

## GTQ-BS Series Fixed Gas Detector Operation Manual

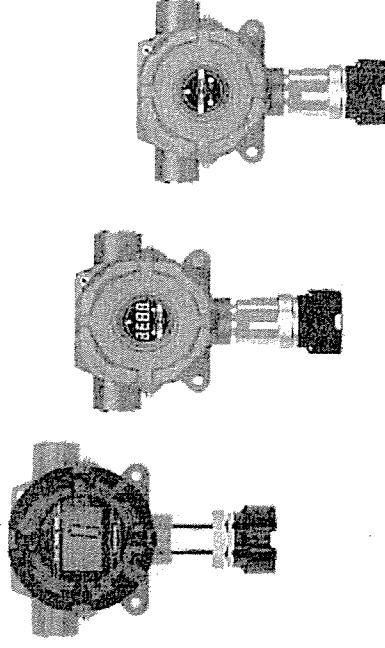

**Hanwei Electronics Group Corporation**  
Address: No.169, Xuesong Road, Hi-Tech Zone,  
Zhengzhou 450001, China  
Tel.: 0086-371-67169080  
Fax: 0086-371-67169090  
E-mail: sales@hwsensor.com  
Website: www.hwsensor.com

**Hanwei Electronics Group Corporation**

Ver. No.: 2024083005WY

Thank you for purchasing our products. When you are ready to use this product, please be sure to read the instruction carefully and follow the relevant operation steps provided, so that you can fully enjoy the service provided by our company, and avoid damage to the machine or other accidents caused by incorrect operation. If the user does not follow this manual to install or repair the replacement parts, the resulting liability of our company is not responsible.

Hanwei Electronics is solely responsible for the edition and amendment of this manual, and try to ensure that the content of the manual is correct. At the same time, the company reserves the right to improve the product and modify the manual without prior notice. The pictures in this manual are only for function description. If it does not match the actual product, please refer to the actual product.

Please keep this manual properly so that you can refer to it and get help whenever you need it in the future.

### **Symbol definition**

Before using the product, please be familiar with the symbol definition possibly appears in the operation manual:



Attention - It's possibly hurting yourself or others.



Caution - It's possibly damaging the detector or other equipment.



Remark - Annotation, use tips or additional information.

[ ] Indicates the menu item of point type gas detector (hereinafter referred to as "detector").

### **Copyright Statement**

The copyright of this operation manual is owned by Hanwei Electronics Group Corporation. Without written permission, copy, calibration, or store in database or retrieval system of this operation manual is not allowed, including diffuse it through electronic, copy, record, or other means.

### **User service guide**

- When receiving the device, please check whether the accessories and inspection report certificate are complete. If there is any missing, please contact the vendor or manufacturer immediately.
- Within 12 months after the product is sold, under the normal operation by following the requirements of storage, transportation and operating, if the product quality is below the technical index, the user can get free services and repairs through the warranty card.
- If you have any query or dissatisfaction about our product and service, including product technology, quality, installation & maintenance, service attitude and charging rates, please contact the vendor or manufacturer in time. Your suggestion will be well treated immediately.

### **Safety Information**

Before using the product, please read the following safety information, and follow the related operation requirements strictly.

- Please don't use the gas detector which is broken. Please check whether there is crack in the housing or there is short of accessories about the gas detector. If the gas detector has already broken or short of accessories, please contact the vendor or manufacturer.
- The device is calibrated well before leaving the factory. In order to ensure the detection accuracy and reliability, we suggest the user make re-calibration before using on site.

- In order to ensure the user's safety and the detector can work normally, please make Bump Test (put the device in the target gas of a high concentration than high alarm) before normal operation. If the device testing result is not within the required range, please make calibration in time.
- If the detector is exposed to high concentration of mixed gas or high humidity and high temperature environment for a long time, it may cause pollution or sensitivity reduction of the sensor. In this case, the detector needs to be calibrated frequently to ensure reliable operation and correct indication.
- Disconnect power supply before opening. Be sure not to open the housing or change sensor where dangerous gas may be present.
- This gas detector must be installed strictly in accordance with the operation manual and following the national and local electrical installation requirements. Otherwise it may lead to unpredictable and serious consequences.
- The inside of the sensor may contain corrosive electrolyte, so please treat it carefully. If there is leakage, the sensor must be immediately transferred and treated appropriately. Please avoid the electrolyte to touch the skin, clothes, or other instrument circuit, to avoid personal injury or damage to the equipment.
- The detector must be safely grounded to prevent RF interference.
- It is forbidden to block or obscure the detection part during the use of the detector, otherwise it will lead to failure of the detector.
- When the flammable gas sensor is affected by poisonous gas or other inhibitors (such as silicone, sulfur, lead, or halogenated hydrocarbons, etc.), the sensitivity will be reduced.
- Spraying or painting of the detector is not allowed. If the coating has been sprayed, attention must be paid to ensure that the coating is not deposited at the entrance of the sensor. Otherwise, it will hinder the flow and diffusion of the measured gas and affect the test accuracy.

- In the maintenance process, it is strongly recommended to use original accessories of Hanwei company, so as not to damage the equipment or reduce the performance of the equipment. Unauthorized replacement of parts may compromise the internal security of the detector.
- Do not replace the sensor in an organic solvent or flammable solution.
- Avoid frequent exposure of the device to high concentration gas which concentration is beyond the detection range. Otherwise, the sensor life will be shortened.
- It is forbidden to disassemble, adjust or repair the gas detector without permission. Any operation inside the detector should be carried out by professionals.
- Avoid the detector from electric shock or severe and continuous mechanical impact.

### 1. Product introduction

GTQ-BS series fixed gas detectors (hereinafter referred to as BS series detector) are new type of gas detection instrument produced by our company. They adopt high-performance gas-sensing components and micro-controller technology, combined with sophisticated SMT technology.

With the advantages of good repeatability, good temperature and humidity characteristics, long lifetime, and convenient operation, they are suitable for detecting gas concentration in an industrial environment, like petroleum and petrochemical industry refineries, chemical plants, metallurgical industry, power industry and other places that may produce gases that cause explosion or harmful to the human body.

The GTQ-BS series detectors include 3 models of BS01, BS02, and BS03. Main features and difference of them are shown in below table:

Model	Status Indicators	Relay Output	IR remote controller	LED display	LCD display
BS01	√	√ note 1	√ note 4		
BS02	√	√ note 2	√ note 4	√	
BS03	√	√ note 3	√ note 4		√

**Note 1:** 1 Dry relay output, K1 relay specification, 24V@3A.

**Note 2:** 2 Dry relay output, K1, K2 relay specifications, 24V@3A.

**Note 3:** 2 Dry relay output, K1 and K2 relay specifications, 24V@3A; 1 active contact output. K3 is the active signal contact output. The specification is 24V@0.5A.

**Note 4:** See Chapter 6.1 of this manual.

## 2. Technical Parameters

Sensor principle	Catalytic, electrochemical, infrared				
Sampling method	Diffuse naturally				
Working voltage	DC24V±6V				
Power consumption	≤2.5W				
Alarm deviation	±3% alarm points				
Response time	Flammable: $T_{90} \leq 20s$				
	O <sub>2</sub> , CO, H <sub>2</sub> S: $T_{90} \leq 30s$				
	Other gases: $T_{90} \leq 60s$				
Signal output	4-20mA or RS485 Power Bus				
Working method	Continuously detection				
Operation method	IR remote controller				
Status indicators	Yellow---Fault alert				
	Red---Low alarm and high alarm				
	Green---Normal monitoring				
Working temperature	Flammable: -40°C to +60°C				
	Other gases: -20°C to 50°C				

Working humidity	≤95%RH (no condensation)	
Air pressure	86kPa to 106kPa	
Ingress protection	IP66/67	
Ex-proof grade	II 2 G Ex db IIC T6/T5 Gb	
	II 2 D Ex tb IIC T80°C/T95°C Db	
Enclosure material	Aluminum alloy (optional stainless steel)	
Dimension	BS01/BS02: 130mm x 154mm x 83 mm	
	BS03: 130mm x 154mm x 95 mm	
Weight	About 1.2kg (4.5kg for stainless steel)	
Thread screw	NPT3/4	
Cable required	RVVP cable, 4 x 0.75mm <sup>2</sup>	
Sensor life	Combustible catalytic: 3 years	
	Electrochemical: 2 years	
	Infrared sensor: 5 years	

## 3. Structure and dimension drawings

### 3.1 Structure Drawing

BS series detectors are mainly composed of housing, sensor module, transmitter, etc. The housing is mainly composed of upper cover, O-ring, lower housing, sealing plug, protective cover, bulkhead, and plug, etc.

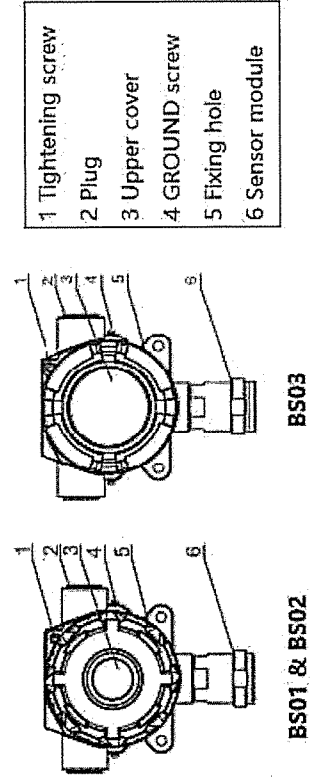

### 3.2 Dimension Drawing (Unit: mm)

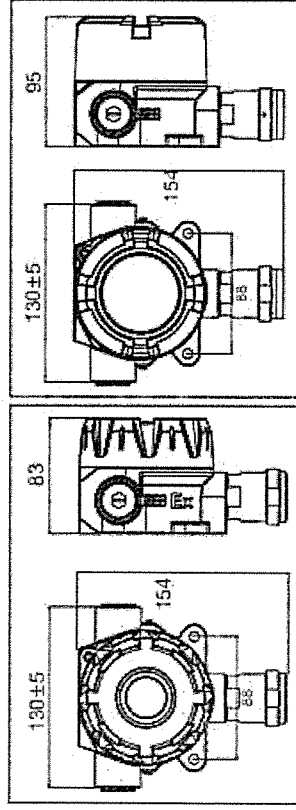

**BS01 & BS02**

**BS03**

## 4. Installation

### 4.1 Installation and working environment requirements

- The environment where the detector is installed must meet the atmospheric pressure: 86kPa~106kPa, altitude below 1300m;
- When the detector is located on the upwind side of the minimum frequency wind direction of the release source, the distance between the combustible gas detector and the release source should not be more than 15m, and the distance between the toxic gas detector and the release source should not be more than 2m;
- When the detector is on the leeward side of the minimum frequency wind direction of the release source, the distance between the combustible gas detector and the release source should not be more than 5m, and the distance between the toxic gas detector and the release source should not be more than 1m;
- If the combustible gas release source is in a closed or poor ventilated semi-open factory building, the detectors should be installed every 15m. And the distance between the detector and any release source within its coverage area should not be more than 7.5m. The toxic gas detector should not be more than 1m away from the release source;

- For combustible gas or toxic gas lighter than air, if the gas release source is in a closed or poor ventilated semi-open workshop, besides install a detector above the release source, a combustible gas detector or toxic gas detector should also be installed at the highest point in the workshop where gas is likely to accumulate.
- The installation height of the detector for detecting combustible gas whose relative gravity is heavier than air should be 0.3m~0.6m from the ground (or floor). Detectors for detecting toxic gases whose relative gravity is heavier than air should be close to the leak point, and their installation height should be 0.3m~0.6m from the ground (or floor);
- The installation height of the detector for detecting combustible gas or toxic gas whose relative gravity is lighter than air should be 0.5m~2m higher than the release source;
- The detector should be installed in a place where there is no impact, no vibration, no strong electromagnetic field interference, and easy to repair. There should be no less than 0.5m of clearance and access channels between the place where the detector is installed and the surrounding pipelines or equipment;
- For the underground integrated pipe gallery, when the detected gas density is less than the air density, the detector should be installed at a position no more than 0.3m away from the top of the pipe gallery. When the density is greater than or equal to the air density, the detector should be installed at a location 0.2m~0.3m from the pipe gallery floor; the oxygen detector should be installed at a location of 1.6m~1.8m away from the pipe gallery floor.

### 4.2 Installation Method



#### Remark:

- When installing the gas detector, make sure that its sensor is downward.

- When this product is installed and used, it should be equipped with a filler type cable entry device that has obtained the explosion-proof certificate and the explosion-proof mark is Ex d IIC Gb/Ex Td A21 IP66.

According to the actual condition of the detection site, the detector is fixed on the wall or pipeline. The structure design supports a variety of installation methods, which is convenient and flexible. Users can choose the appropriate installation method by themselves. The matched mounting frame below needs to be purchased by the user.

**Method 1 (Wall-mounting):** Determine the hole location according to the installation plate, and then use two M6x70 expansion bolts to fix it firmly against the installation hole of the detector.

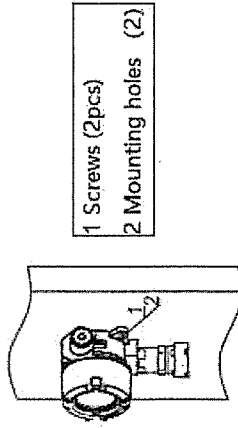

**Method 2 (Holding pipe fixing method):** When there is a pipeline on site, the U-shaped card matched with the detector is used to fix the detector on the pipeline

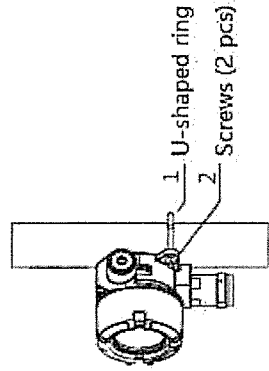

## 5. Cable Connection

**⚠ Caution:** The supplied voltage of the detector cannot exceed DC30V. Otherwise, it will cause permanent damage to the detector. And it cannot be lower than DC18V, because the detector may not work normally.

### 5.1 Wiring connection of 4-20mA type:

It can be connected any control panel or system which supports 4-20mA signal input such as DCS, PLC, etc. Pay attention that the transmission distance of 4-20mA signal should be less than 1000 meters, and the loop resistance should not exceed 500 ohms.

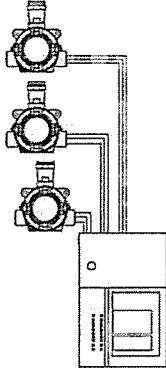

It is recommended to use a shielded 3-core cable with a diameter of about 9mm during on-site construction. The rubber rings in the pipe joints on both sides of the detector must hold the cable tightly, otherwise the product's own protection level and explosion-proof performance may be reduced.

### 5.2 Wiring connection of RS485 Power Bus type:

RS485 Power Bus is a new type of communication method developed by our company. It has the advantages of long communication distance and stable communication signal. This type of gas detectors can only be connected with our own panels like KB100 model and KB500 model.

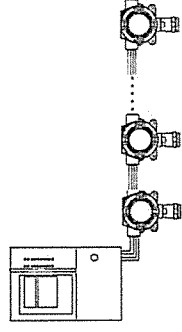

### 5.3 Internal wiring method



**Attention:** The power must be turned off when doing wiring.  
According to the site conditions, the detector can be fixed before wiring,  
or it can be connected first and then fixed.



**Remark:** Connecting the control panel and the detector by using  
the RWVP4\*0.75 shielded cable (the maximum distance between the  
detector and the controller is 1000m).

The internal wiring steps are as follows:

- Rotate the upper cover of the detector counterclockwise, and then you can see the circuit board tray in the housing.
- Turn counterclockwise to unscrew the plastic plug, then screw on the explosion-proof gland clockwise, and then put the four-core cable through the explosion-proof gland and sealing plug in turn, and pass it into the cavity from the wiring hole.
- Take out the circuit board tray in the housing, and unplug the male plugs on J1 and J2 inserted on the circuit board terminals. Connect the wires to the male plugs according to the marks by following the below table instruction. After connecting the wires, insert the terminal block into the corresponding terminal block, and at the same time, fasten the cable shielding layer to the outside of the housing through a nut to ensure the reliable grounding of the housing.
- Tighten the rubber sealing ring and hold the cable tightly. When using explosion-proof hoses, it can also be directly connected to the detector.
- After ensuring that the first 4 steps are correct, make sure that the O-ring is put on and tightly integrated with the upper cover, and turn the upper cover clockwise until it is tightened.



**Caution:** According to explosion-proof requirements, please do  
not remove the explosion-proof gaskets from the unused wiring holes,  
and don't throw away the components on the detector housing and  
internal circuit board.

Below is the drawing and illustration of the detector terminal block.

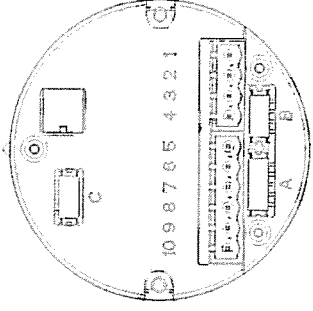

No.	Name	Function
1	K2COM	COM of 2 <sup>nd</sup> relay
2	K2NO/NC	NO / NC of 2 <sup>nd</sup> relay
3	K3COM	Voltage output of 3 <sup>rd</sup> relay
4	GND OUT	GND of 3 <sup>rd</sup> relay
5	Vin	Power input DC24V+
6	GND	Power input DC24V -
7	I / L+	RS485 output + / current (4-20mA)
8	L-	RS485 output - / no connection (4-20mA )
9	K1COM	COM of 1 <sup>st</sup> relay
10	K1NO/NC	NO / NC of 1 <sup>st</sup> relay

**Note 1:** If the detector is the RS485 type, No. 7 terminal is the positive pole, and No. 8 terminal is the negative pole. If is 4-20mA type, then No.

7 terminal is the current communication output pin, and No. 8 terminal is not wired.

**Note 2:** A port terminal is used to connect the sensor module and has the function of anti-reverse connection.

**Note 3:** B port terminal is the wiring port of digital sound and light alarm

**Note 4:** C port terminal is the wiring port of the wireless module.

**Note 5:** Relays are NO (normally open).

### 6. Menu operation

The operation and setting of the detector are carried out by the IR07 remote controller which can be supplied only by our company Hanwei Electronics Group Corporation. Below is the introduction of the IR07 remote controller.

#### 6.1 Parameters

Power source	2pcs of AAA alkaline batteries
Dimension	133mm x 50mm x 24mm
Working temp.	- 10°C ~ 50°C
Storage temp.	- 20°C ~ 60°C
Humidity	≤98%RH (no condensation)
Air pressure	86kPa~110kPa
Display	128x64 dot matrix LCD

#### 6.2 Function

S/N	Function	Explanation
1	L ALARM	To set the low alarm value of detector
2	H ALARM	To set the high alarm value of detector
3	ZERO	To make zero calibration of detector
4	CAL	To make span calibration of detector
5	ADDRESS	To set the addressable code of detector

### Button explanation

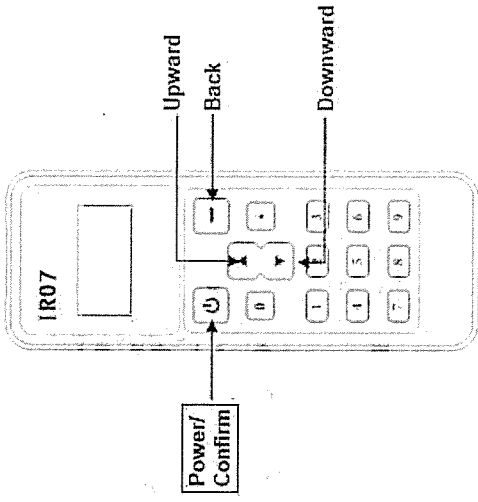

### 6.3 Operation instruction

#### 6.3.1 Power on:

Press "Power/Confirm" button to power on the controller. The controller enters standby interface as shown in below drawing:

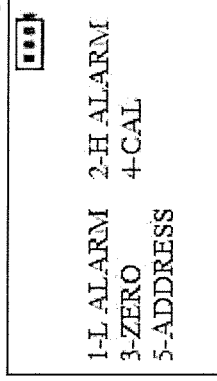

#### 6.3.2 Power off:

- In standby interface, press "Power/Confirm" button to power off the controller manually.
- Automatically power off when battery voltage is not enough.
- Automatically power off if no operation within 120 seconds.



**Caution:** It is forbidden to replace the battery of the remote

controller and open the cover of the instrument in a dangerous area!

If it is not used for a long time, the battery in the remote controller should be taken out.

### 6.3.3 Language setting

In standby interface, press both "Power/Confirm" button and figure "9" to switch the language between Chinese and English.

### 6.3.4 Mode switch

This controller has 2 modes of IR07 and IR03. Press both "Power/Confirm" button and "back" button, user can switch between these 2 buttons. **While, for Hanwei latest fixed gas detectors of GTQ-BS series, GTQ-WD series and GTYQ-WD6200IRII, please select IR07 mode.**

### 6.3.5 Shortcut operation

In standby interface, user can press below figure buttons to make the setting.

Figure 1: Low alarm setting

Figure 2: High alarm setting

If user wants to set the alarm values, press the number button 1 or 2, and the controller will display the alarm setting interface. After setting the value through the number buttons, aim the controller at the infrared receiving part of the detector, and press the "Power/Confirm" button to send the parameters to the detector. If the setting is successful, the green LED of the detector flashes twice quickly. If the setting fails, the yellow LED of the detector flashes twice quickly. After the setting is completed, user can press "Power/Confirm" button to save the setting or press "Back" button to exit to the standby interface.

### Zero calibration

After the detector have been used for a long time, or the detector was put in a new type environment, it may not display "0" in clean air. This phenomenon is called "zero drift". Zero drift is normally caused by big change of temperature or humidity, and this phenomenon can be

corrected by zero calibration. Zero calibration procedure is as below:

- Put the detector in the clear air.
- After the detector works stably for 20 minutes, press the figure button 3, and the controller will display the zero calibration interface.
- If the calibration is successful, the green LED of the detector flashes quickly. If the calibration fails, the yellow LED of the detector flashes quickly.

After zero calibration, if the detector is still not displaying the right value, then user is suggested to do span calibration as below.

### Span calibration

- Put the detector in the clear air.
- After the detector works stably for 20 minutes, press the figure button 4 of the remote controller, it enters the span calibration.
- Enter the standard gas value by pressing the figure buttons of the remote controller.
- Press the "Power/Confirm" button to start the span calibration, which will take about 2 minutes.
- If the calibration is successful, the green LED of the detector flashes quickly. If the calibration fails, the yellow LED of the detector flashes quickly.

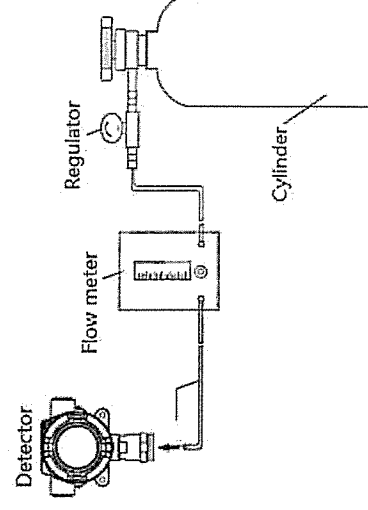

**Figure 5: Addressable code setting (of RS485 gas detectors)**

For the RS485 type of fixed gas detectors, if user needs to communicate with the control panel, he needs set the addressable code of the detector in advance. The specific operations are as follows:

- In the standby interface, press the figure button 5 of the remote controller, and the remote controller enters the setting interface.
- According to the actual on-site situation, press the figure buttons to input each detector's address code.
- After setting the value through the number buttons, aim the controller at the infrared receiving part of the detector, and press the "Power/Confirm" button to send the parameters to the detector.
- If the setting is successful, the green LED of the detector flashes twice quickly. If the setting fails, the yellow LED of the detector flashes quickly.

## 7. Precautions for operation and maintenance



**Caution:** Debugging should be carried out by trained persons.

- In order to avoid personal injury, the detector must be wired when the power is off.
- The personnel on duty should regularly clean the dust on the surface of the detector housing with a dry cloth or vacuum cleaner. Liquid cleaning or wet cloth is not adoptable.
- In order to better ensure the detection accuracy and reliability of the detector, it is recommended to perform a zero calibration before the first use, and then calibrate the sensor at least once every six months.
- Avoid electric shocks or severe and continuous mechanical shocks to the detector.
- Do not paint sensor components or detectors.
- There must be no fast-flowing gas directly blown through the detector, otherwise it will affect the test results.

- Avoid frequent contact of the detector with high-concentration gas samples whose concentration exceeds the detection range, otherwise the life of the sensor will be shortened.
- Water or dust must be strictly prohibited from entering the detector cavity through pipes or wires to avoid damage to the detector.
- If you need to repair or replace parts of the detector, please contact your dealer or manufacturer.

## 8. Troubleshooting guidance

Fault	Possible reason	Solution
No response to gas	Warm-up doesn't ends	Wait ftil warm-up ends
	Sensor module fault	Contact seller for service
	PCBA fault	Contact seller for service
E-01	Calibration fault	Re-calibrate the detector
E-02	Wiring fault, connection fault or sensor fault	Reconnect the wire or replace sensor
E-03	Communication fault	Check the wire between sensor and transmitter
E-04	Sensor drift	Re-calibrating or replace sensor
E-05	Sensor not calibrated	Re-calibrating

## Appendix 1: Description of working states of BS series

The working states of BS series detectors are divided into the following seven. Among them, the calibration reminder and parameter configuration functions are independent sub-functions under the normal monitoring state, and the alarm state and the fault state are the sub-states of the normal monitoring state.

- S1: Initialization state
- S2: Warming-up state
- S3: Normal monitoring state: This state is the normal working state

- of the detector when doing gas concentration detection and proceed periodic self-checking (the self-checking cycle is: 500ms, to diagnose if the sensor has a short circuit or open circuit fault). This state supports parameter setting and calibration reminder function.
- S4: Alarm state: The state is divided into 3 sub-states: high alarm, low alarm, and over-range alarm. This state supports parameter setting and calibration reminder function. And the alarm state is prior to the fault state.
- S5: Fault state: In this state, the real-time communication with the control panel is interrupted. This state doesn't support parameter setting and calibration reminder functions.
- S6: Parameter setting states: This state is the working state when doing settings on the detector through IR05 infrared remote controller and control panel. The remote controller and the control panel can alternately execute the parameter settings where there are intersections, regardless of priority. The latest successful settings do effects to the detector.

## LED indicator and relay action under different states

Status	Red LED	Yellow LED	Green LED	Low alarm relay	High alarm relay
S1	Off	Off	Off	No action	No action
S2	Off	Off	Lighting	No action	No action
S3	Off	Off	Flash slowly	No action	No action
S4	Flash slowly	Off	Off	Activated	No action
	Flash quickly	Off	Off	Activated	Activated
	Flash quickly	Off	Off	Activated	Activated
S5	Off	Flash slowly	Off	No action	No action
S4+S5	As S4	Flash slowly	Off	Activated	Activated
S6	See Below chart				

S6: Parameter setting states. When doing settings through remote controller, the states shown as below:

S6	Green LED flash three times	Yellow LED flash three times
States	Setting successfully	Setting fault, refuse to set

### Notes:

- When the indicator light is flashing, the corresponding blank occupancy is: 50%;
- The indicator light flashes slowly, indicating that it continues to flash

- in this state, and the flashing frequency is 2 Hz;
- The indicator light flashes in normal frequency, indicating that it continues to flash in this state, and the flashing frequency is 5 Hz;
- The indicator light flashes quickly, indicating that it continues to flash in this state, and the flashing frequency is 10 Hz
- "\_" means that the function is in the normal working state, and the alarm and fault indicator lamps and the low and high alarm relays work normally.
- The device has high concentration protection function for flammable sensor. If gas concentration reaches or exceeds the full-range level, the detector will keep alarming status for 3 minutes which cannot be reset manually. This is to inform the user of the hazard existing. Please take effective measurements to avoid hazard happening.

COCl2	0-5ppm		√
ClO2	0-10ppm		√
NO2	0-20ppm		√

## Appendix 2: Measuring Gas List

Gas	Range	BS01	BS02	BS03
CH4	0-100%LEL	√	√	√
Isobutane	0-100%LEL	√	√	√
LEL	0-100%LEL	√	√	√
O2	0-25%VOL		√	√
CO	0-500ppm		√	√
H2S	0-100ppm		√	√
SO2	0-30ppm			√
NH3	0-100ppm			√
CL2	0-10ppm			√
H2	0-1000ppm			√
HF	0-10ppm			√
O3	0-5ppm			√
HCN	0-20ppm			√